

# TOWN OF ELLINGTON

Building Department  
57 Main Street  
Ellington, CT 06029  
(860) 870-3124

## Deck Guidelines

*All information in this handout pertains to 1 and 2 family residential decks. The Town of Ellington is offering this informational handout as representative of typical issues/questions that may arise on a typical job. The Town assumes no responsibility for any errors, omissions and installer is required to follow applicable codes. No handout could possibly cover all situations, nor is it intended to.*

### IMPORTANT NOTES:

1. If you plan to install a hot tub, spa, pool, screen room, sunroom or future addition on proposed deck, **this handout does not apply.**
2. If proposed deck is in area of electric or gas service, oil fill and vent or other utilities additional requirements apply and are outside the scope of this handout. Contact Building Department for additional information as needed.
3. If any direct vent exhaust is located in area of proposed deck, then additional requirements apply. Refer to manufacturers installation instructions of equipment for required clearances.

### PERMIT APPLICATION:

Please submit the following information.

1. Plot plan (land use department can supply) with proposed deck drawn to scale. Zoning approval will be required. If you have a well and/or septic, health department approval will be required as well.
2. Floor plan drawn to scale.
  - Show deck size.
  - Size and spacing of floor joists.
  - Size and type of decking material.
  - Size, type, location and spacing of posts.
  - Size, type, location of beams.
3. Elevation plan drawn to scale.
  - Show height of structure from grade.
  - Size and depth of footings.
  - Guard and handrail height and spacing (if any).
  - Stairwell rise/run and guard and handrail height (if any).
  - Show any utilities (i.e.: overhead wires).
  - Note attachment detail for ledger and also, include type of flashing to be used on ledger.
4. Permit Fee.  
See most recent fee schedule.

## DECK GUIDELINES

Connecticut has adopted the 2009 International Residential Code as of February 28, 2014. The American Wood Council has created a deck building guide based on this code. The web address for the DCA6 guide is: <http://www.awc.org/publications/dca/dca6/dca6-09.pdf> . This guide is a great reference for deck building and details some of the changes with this code.

### STRUCTURAL NOTES:

Proper ledger attachment is crucial to structural safety of deck. If structure you are attaching deck onto has any of the following conditions then deck should be independently supported:

1. Cantilevered.
2. Brick or other soft masonry.
3. Supported on piers/posts.

If structure is typical wood frame on continuous foundation without any cantilever then ledger attachment spacing noted below can be used.

**R502.2.2.1 Deck ledger connection to band joist.** For decks supporting a total design load of 50 pounds per square foot (2394 Pa) [40 pounds per square foot (1915 Pa) live load plus 10 pounds per square foot (479 Pa) dead load], the connection between a deck ledger of pressure-preservative-treated Southern Pine, incised pressure-preservative-treated Hem-Fir or *approved* decay-resistant species, and a 2-inch (51 mm) nominal lumber band joist bearing on a sill plate or wall plate shall be constructed with 1/2-inch (12.7 mm) lag screws or bolts with washers in accordance with Table R502.2.2.1. Lag screws, bolts and washers shall be hot-dipped galvanized or stainless steel.

**TABLE R502.2.2.1 FASTENER SPACING FOR A SOUTHERN PINE OR HEM-FIR DECK LEDGER AND A 2-INCH NOMINAL SOLID-SAWN SPRUCE-PINE-FIR BAND JOIST<sup>c, f, g</sup>**  
(Deck live load = 40 psf, deck dead load = 10 psf)

JOIST SPAN	6' and less	6'1" to 8'	8'1" to 10'	10'1" to 12'	12'1" to 14'	14'1" to 16'	16'1" to 18'
<b>Connection details</b>	<b>On-center spacing of fasteners<sup>d, e</sup></b>						
1/2 inch diameter lag screw with 15/32 inch maximum sheathing <sup>a</sup>	30	23	18	15	13	11	10
1/2 inch diameter bolt with 15/32 inch maximum sheathing	36	36	34	29	24	21	19

## DECK GUIDELINES

1/2 inch diameter bolt with 15/32 inch maximum sheathing and 1/2 inch stacked washers <sup>b, h</sup>	36	36	29	24	21	18	16
---	----	----	----	----	----	----	----

- a. The tip of the lag screw shall fully extend beyond the inside face of the band joist.
- b. The maximum gap between the face of the ledger board and face of the wall sheathing shall be 1/2".
- c. Ledgers shall be flashed to prevent water from contacting the house band joist.
- d. Lag screws and bolts shall be staggered in accordance with **Section R502.2.2.1.1**.
- e. Deck ledger shall be minimum 2 × 8 pressure-preservative-treated No. 2 grade lumber, or other approved materials as established by standard engineering practice.
- f. When solid-sawn pressure-preservative-treated deck ledgers are attached to a minimum 1 inch thick engineered wood product (structural composite lumber, laminated veneer lumber or wood structural panel band joist), the ledger attachment shall be designed in accordance with accepted engineering practice.
- g. A minimum 1 × 9 1/2 Douglas Fir laminated veneer lumber rimboard shall be permitted in lieu of the 2-inch nominal band joist.
- h. Wood structural panel sheathing, gypsum board sheathing or foam sheathing not exceeding 1 inch in thickness shall be permitted. The maximum distance between the face of the ledger board and the face of the band joist shall be 1 inch.

**R502.2.2.1.1 Placement of lag screws or bolts in deck ledgers.** The lag screws or bolts shall be placed 2 inches (51 mm) in from the bottom or top of the deck ledgers and between 2 and 5 inches (51 and 127 mm) in from the ends. The lag screws or bolts shall be staggered from the top to the bottom along the horizontal run of the deck ledger.

**R502.2.2.2 Alternate deck ledger connections.** Deck ledger connections not conforming to Table R502.2.2.1 shall be designed in accordance with accepted engineering practice. Girders supporting deck joists shall not be supported on deck ledgers or band joists. Deck ledgers shall not be supported on stone or masonry veneer.

**R502.2.2.3 Deck lateral load connection.** The lateral load connection required by **Section R502.2.2** shall be permitted to be in accordance with Figure R502.2.2.3. Hold-down tension devices shall be installed in not less than two locations per deck, and each device shall have an allowable stress design capacity of not less than 1500 pounds (6672 N).

## DECK GUIDELINES

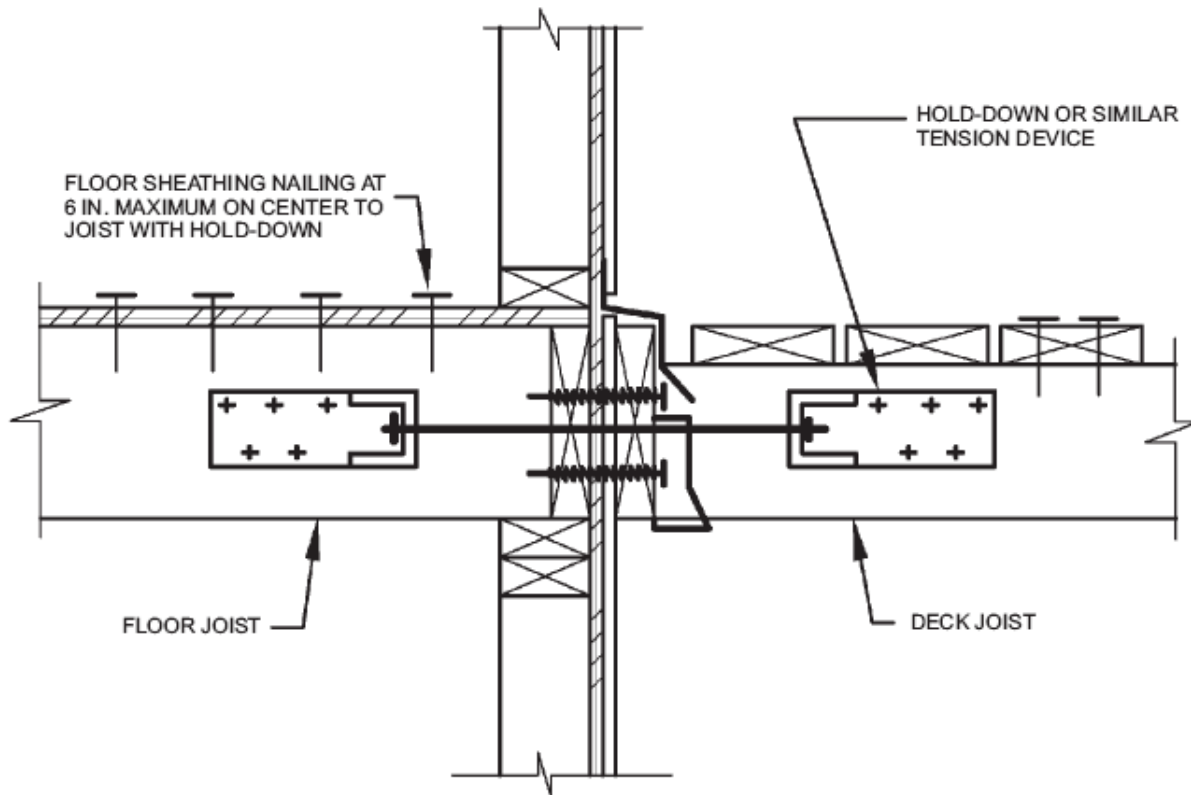

For SI: 1 inch = 25.4 mm.

**FIGURE R502.2.2.3 DECK ATTACHMENT FOR LATERAL LOADS**

Decks not supported by dwelling do not need frost protection footings.

- Wood must be pressure treated or naturally decay resistant.
- Fasteners must be compatible with wood used. Hot dipped galvanized or stainless steel fasteners must be used with pressure treated lumber.
- Piers are required to be 42" deep for frost protection. Piers need to be calculated based on the tributary deck area it's supporting and the soil bearing capacity.
- Posts must be of sufficient size to support loads, and positively attached to piers.
- Beams must be positively attached to posts with gussets or hardware designed for this purpose.
- All splices in beams must be supported by posts. *No mid-span splices*. Beams required to have minimum 1 1/2" bearing on wood and 3" on concrete.
- Joists shall be supported by properly sized hanger, or minimum 2"x2" ledger strip.
- If deck is greater than 5' high, depending on size and structural details, diagonal bracing may be required at posts.

## DECK GUIDELINES

### DECK JOIST TABLE

#### JOIST

Southern Pine	2x6	16" on center	9' 0"
Southern Pine	2x8	16" on center	11' 10"
Southern Pine	2x10	16" on center	14' 0"
Southern Pine	2x12	16" on center	16' 6"

The above spans are from Southern Pine Joist and Rafter span chart for a 40-pound per square foot (psf) live load and a 10 psf dead load with a 360 deflection and a moisture content above 19% due to exposed exterior location. Go to the website for Southern Pine Council at [www.southerpine.com](http://www.southerpine.com) for more details. Also consult the DCA6 guide for span lengths, overhang lengths, beam sizing, and pier information.

Posts to girder attachment should be braced to prevent girder from "rolling" (Figure 3). Any seams or splices in the girder *must* be over the posts (Figure 4).

#### *Post to girder Attachment Detail*

(Figure 3)

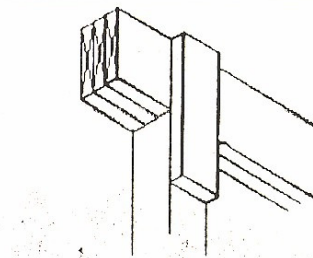

**2x6 Gusset attached to side of post and girder**

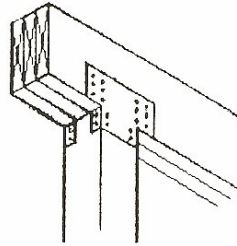

**Mechanical fasteners install as per manufactures instructions**

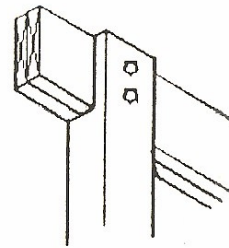

**Post notched and bolted to girder**

# DECK GUIDELINES

## STAIRWAYS

**WIDTH:** Stairways shall not be less than 36 inches in clear width at all points above the permitted handrail height and below the required headroom height. Handrails shall not project more than 4.5 inches on either side of the stairway and the minimum clear width of the stairway at and below the handrail height, including treads and landings, shall not be less than 31.5 inches where a handrail is installed on one side and 27" where handrails are provided on both sides.

**HEADROOM:** The minimum headroom in all parts of the stairway shall not be less than 6 feet 8 inches measured vertically from the sloped plan adjoining the tread nosing or from the floor surface of the landing or platform.

**RISER HEIGHT:** The maximum riser height shall be 8 1/4" inches. The riser shall be measured vertically between leading edges of adjacent treads. The greatest riser height within any flight of stairs shall not exceed the smallest by more than 3/8".

**TREAD DEPTH:** The minimum tread depth shall be 9 inches. The tread depth shall be measured horizontally between the vertical planes of the foremost projection of adjacent treads and at a right angle to the tread's leading edge. The greatest tread depth within any flight of stairs shall not exceed the smallest by more than 3/8 inch. Winder and circular stairway treads shall have a minimum tread depth of 9 inches measured as above at a point 12 inches from the sides where the treads are narrower. Winder treads shall have a minimum tread depth of 6 inches at any point. The greatest winder tread depth at the 12-inch walk line within any flight of stairs shall not exceed the smallest by more than 3/8 inch. The greatest circular tread depth at any walking line within any circular flight of stairs, measured at a consistent distance from a side of the stairway, shall not exceed the smallest by more than 3/8 inch.

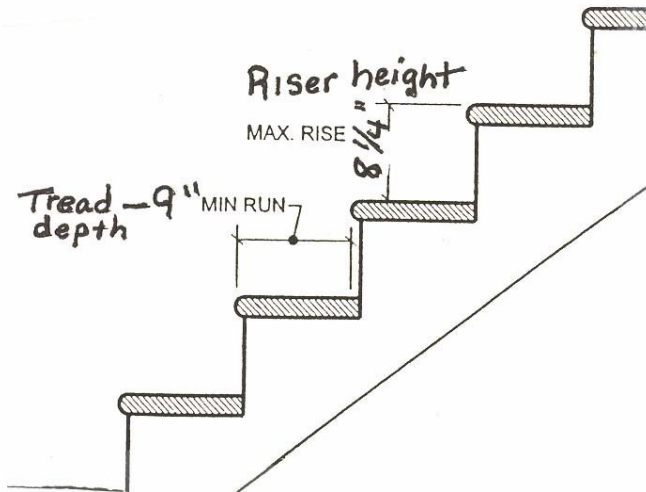

# DECK GUIDELINES

## GUARDS

When guards are required, porches, balconies or raised floor surfaces located more than 30 inches (762 mm) above the floor or grade below shall have guards not less than 36 inches (914 mm) in height. Open sides of stairs with a total rise of more than 30 inches (762 mm) above the floor or grade below shall have guards not less than 34 inches (864 mm) in height measured vertically from the nosing of the treads. Porches and decks which are enclosed with insect screening shall be provided with guards where the walking surface is located more than 30 inches (762 mm) above the floor or grade below. R312.2 Guard opening limitations. Required guards on open sides of stairways, raised floor areas, balconies and porches shall have intermediate rails or ornamental closures which do not allow passage of a sphere 4 inches (102 mm) or more in diameter.

### Exceptions:

- The triangular openings formed by the riser, tread and bottom rail of a guard at the open side of a stairway are permitted to be of such a size that a sphere 6 inches (152 mm) cannot pass through.
- Openings for required guards on the sides of stair treads shall not allow a sphere 4 3/8 inches (107 mm) to pass through.

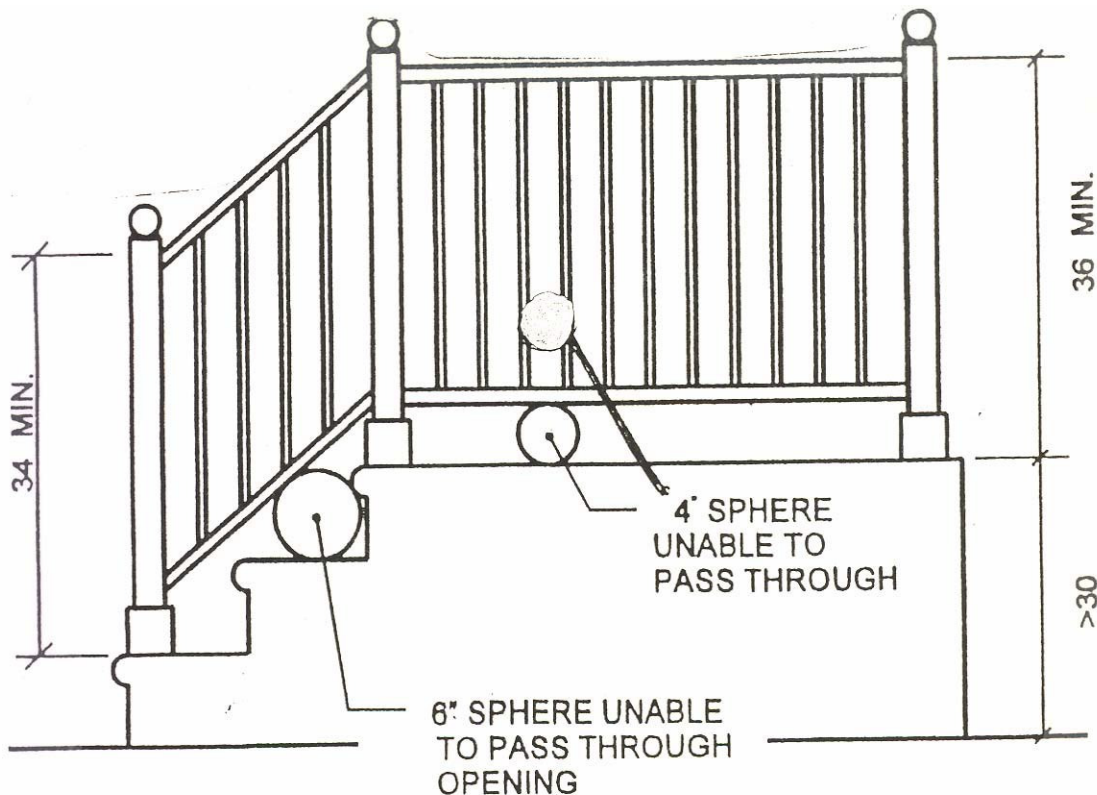

# DECK GUIDELINES

## HANDRAILS

**HANDRAIL GRIP SIZE:** All required handrails shall be of one of the following types or provide equivalent grasp ability.

**Type I:** Handrails with a circular cross section shall have an outside diameter of at least 1 1/4 inches (32 mm) and not greater than 2 inches (51 mm). If the handrail is not circular it shall have a perimeter dimension of at least 4 inches (102 mm) and not greater than 6 1/4 inches (160 mm) with a maximum cross section of a dimension of 2 1/4 inches (57 mm).

**Type II:** Handrails with a perimeter greater than 6 1/4 inches (160 mm) shall provide a grasp able finger recess area on both sides of the profile. The finger recess shall begin within a distance of 3/4" inch (19 mm) measured vertically from the tallest portion of the profile and achieve a depth of at least 5/16 inch (8 mm) within 7/8 inch (22 mm) below the widest portion of the profile. This required depth shall continue for at least 3/8" (10 mm) to a level that is not less than 1 3/4 inches (45 mm) below the tallest portion of the profile. The minimum width of the handrail above the recess shall be 1 1/4 inches (32 mm) to a maximum of 2 3/4" inches (70 mm). Edges shall have a minimum radius of 0.01 inches (0.25 mm).

**CONTINUITY:** Handrails for stairways shall be continuous for the full length of each flight, from a point directly above the top riser of the flight to a point directly above the lowest riser of the flight. Handrail ends shall be returned to a wall or shall terminate in newel posts or safety terminations. Handrails adjacent to a wall shall have a space of not less than 1 1/2 inch between the wall and the handrails.

**Exceptions:** 1. Handrails shall be permitted to be interrupted by a newel post at a level landing. 2. The use of a volute, turnout, starting easing or starting newel shall be permitted over the lowest tread.

1 1/4" - 2" maximum      Minimum 1 1/2" space

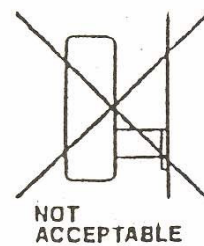
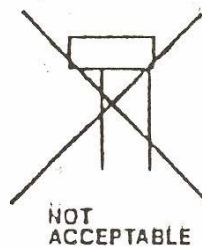
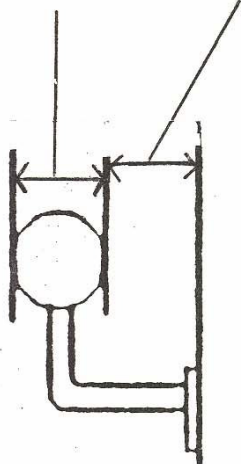



## DECK GUIDELINES

### FLOOR PLAN

1. Proposed deck size.
2. Size and spacing of floor joists.
3. Size and type of decking material.
4. Size, type, location, and spacing of posts.
5. Size and type of beams.

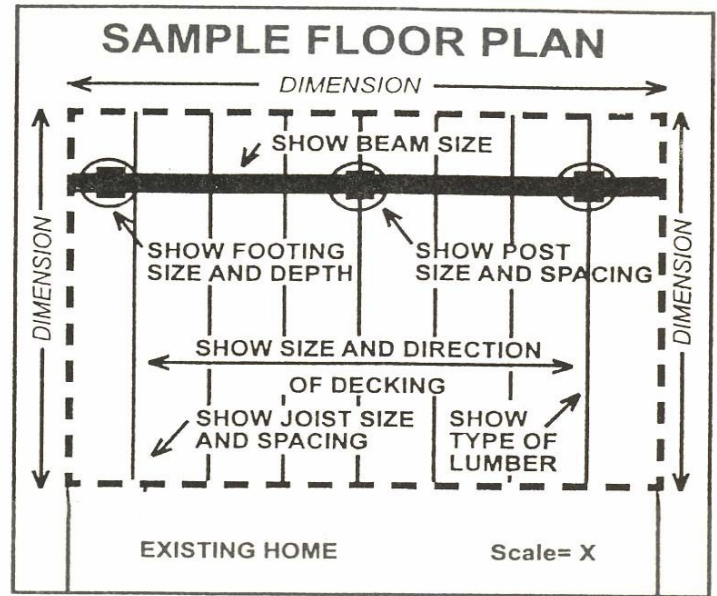

### ELEVATION PLAN

1. Height of structure from grade.
2. Size and depth of footings.
3. Guard height and spacing (if any).
4. Stairway rise/run and handrail height (if any).
5. Clearance of over-head wires (if applicable).
6. Ledger attachment details and flashing information.

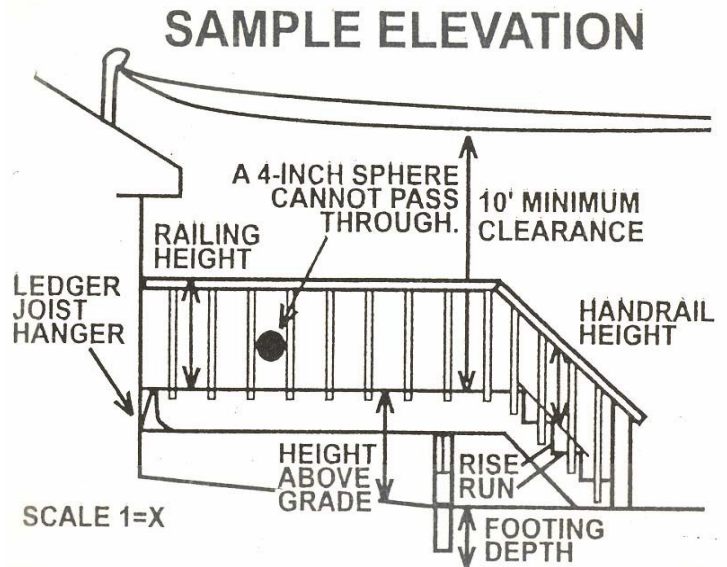

# DECK GUIDELINES

## Southern Pine Span Tables

(The complete book of tables is available in PDF at [www.southernpine.com](http://www.southernpine.com))

Maximum spans given in feet and inches inside to inside of bearings.

**TABLE 12 WET-SERVICE FLOOR JOISTS – 40 PSF LIVE LOAD, 10 PSF DEAD LOAD, 360 DEFLECTION**

Size  ng  inches	Spaci  ng  inches on center	Grade									
		Visually Graded				Machine Stress Rated (MSR)			Machine Evaluated Lumber (MEL)		
		DSS	No.1	No.2	No.3	2400f-2.0E	1650f-1.5E	1500f-1.6E	M-14 (1800-1.7)	M-29 (1550-1.7)	M-12 (1600-1.6)
<b>2x6</b>	<b>12.0</b>	11-0	10-4	9-11	8-2	11-2	10-2	10-4	10-7	10-7	10-4
	<b>16.0</b>	10-0	9-5	9-0	7-1	10-2	9-2	9-5	9-7	9-7	9-5
	<b>19.2</b>	9-4	8-10	8-6	6-5	9-6	8-8	8-10	9-0	9-0	8-10
	<b>24.0</b>	8-8	8-2	7-7	5-9	8-10	8-0	8-3	8-5	8-5	8-3
<b>2x8</b>	<b>12.0</b>	14-5	13-8	13-1	10-3	14-8	13-4	13-8	13-11	13-11	13-8
	<b>16.0</b>	13-2	12-5	11-10	8-11	13-4	12-2	12-5	12-8	12-8	12-5
	<b>19.2</b>	12-4	11-7	10-10	8-2	12-7	11-5	11-8	11-11	11-11	11-8
	<b>24.0</b>	11-6	10-4	9-8	7-3	11-8	10-7	10-10	11-1	11-1	10-10
<b>2x10</b>	<b>12.0</b>	18-5	17-5	16-2	12-6	18-9	17-0	17-5	17-9	17-9	17-5
	<b>16.0</b>	16-9	15-10	14-0	10-10	17-0	15-6	15-10	16-2	16-2	15-10
	<b>19.2</b>	15-9	14-8	12-10	9-10	16-0	14-7	14-11	15-2	15-2	14-11
	<b>24.0</b>	14-8	13-1	11-5	8-10	14-11	13-6	13-10	14-1	14-1	13-10
<b>2x12</b>	<b>12.0</b>	22-5	21-2	19-1	14-9	22-10	20-9	21-2	21-7	21-7	21-2
	<b>16.0</b>	20-4	19-1	16-6	12-10	20-9	18-10	19-3	19-8	19-8	19-3
	<b>19.2</b>	19-2	17-5	15-1	11-8	19-6	17-9	18-1	18-6	18-6	18-1
	<b>24.0</b>	17-10	15-7	13-6	10-5	18-1	16-5	16-10	17-2	17-2	16-10

The spans in these tables were determined on the same basis as the code-recognized *Span Tables for Joists & Rafters* and *Wood Structural Design Data*, both published by the American Wood Council; concentrated loads and uplift loads caused by wind were not considered. See *Using These Tables and Design Assumptions* for additional information. Applied loads are given in pounds per square foot (psf). Deflection is limited to the span in inches divided by 360, 240 or 180 and is based on live load only. The load duration factor,  $C_D$ , is 1.0 unless shown as 1.15 for snow or 1.25 for construction loads. Listed spans are for dry-service conditions unless the table is labeled as *Wet-Service*. Check sources of supply for available grades and sizes, and for lumber longer than 20 feet; an asterisk (\*) indicates the listed span has been limited to 26'-0" based on availability.

Reference design values for Southern Pine lumber are published by the Southern Pine Inspection Bureau after approval by the Board of Review of the American Lumber Standard Committee. Reference design values are based on normal load duration under the moisture service conditions specified.

Because the strength of wood varies with conditions under which it is used, design values should only be applied in conjunction with appropriate design and service recommendations from the National Design Specification® (NDS®) for Wood Construction published by the American Wood Council.

The Southern Forest Products Association (SFPA) does not test lumber or establish design values. Accordingly, neither SFPA, nor its members, warrant that the design values and adjustment factors on which the span tables are based are correct, and disclaim responsibility for injury or damage resulting from the use of such span tables.

The conditions under which lumber is used in construction may vary widely, as does the quality of workmanship. Neither SFPA, nor its members, have knowledge of the quality of the materials, workmanship or construction methods used on any construction project, and, accordingly, do not warrant the technical data, design or performance of the lumber in completed structures.